

INT-01 NFS - 1 KW

GA1+1: LC: (400X800 MM + 400 MM CYLINDER) - 3 KW

DELTA 2500X550 MM - 7 KW

EXT-01 NFS 0.5 KW

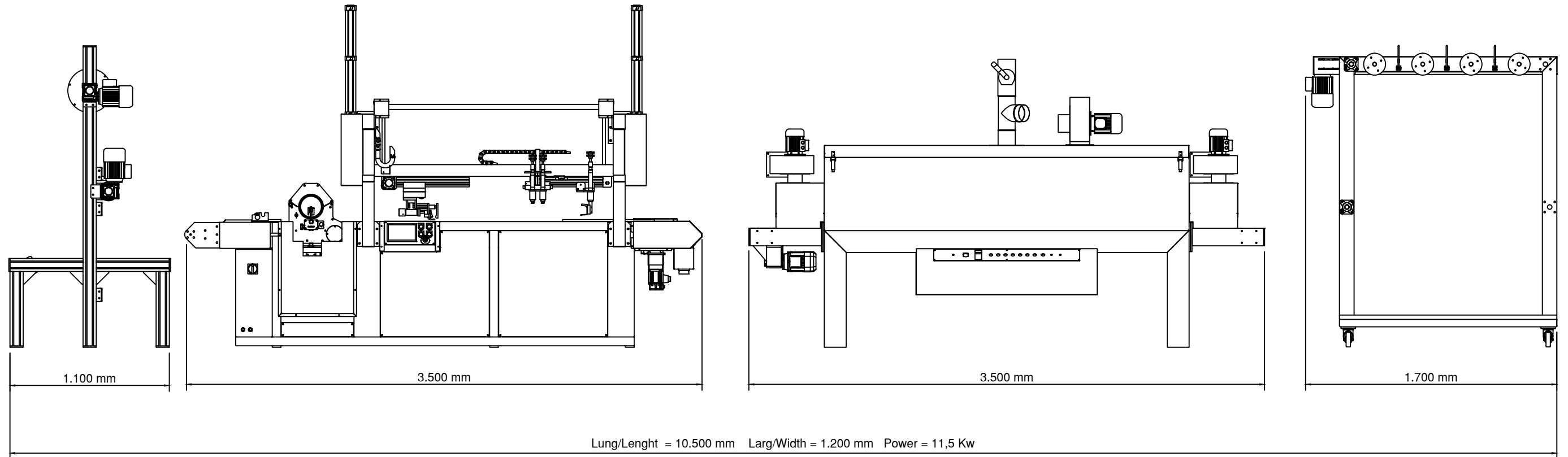

INT-01 NFS + GA1+1: LC: (400X800 MM + 400 MM CYLINDER) + DELTA 2500x550 + EXT-01 NFS